

USER MANUAL

brainLight[®]-4D-Shiatsu-Massage-Chair



brainLight®-4D-Shiatsu-Massage-Chair *Zenese*

Thank you very much for choosing the **brainLight-4D-Shiatsu-Massage-Chair *Zenese***.

Our concept of this chair has been inspired by Eastern philosophy. We have created an elegant interplay of contrasts – yin and yang, soft and strong – that is crucial for harmonizing body, mind, and soul.

Zenese cradles and touches you delicately, but can also give you a strong massage, stretch, and strengthen you — whatever you need to reconnect you with yourself.

Thanks to an intelligent body sensor, the massage chair adjusts its movements not only vertically, horizontally, and in its massage depth to your body, but also detects your individual back contours — that is what we call "4D" technology.

The massage techniques are modeled on both Swedish Massage Therapy and Japanese Shiatsu and work along your acupressure points in order to stimulate the

flowing of your "Qi" energy. The latter concept in turn is based on the meridian theory of Traditional Chinese Medicine (TCM). Let *Zenese* pamper you.

NOTE: We recommend that after every use of the chair – as is recommended after any type of massage – you drink plenty of water, in order to help the removal of toxins and waste from the limbic system.

In order to get the best experience out of the various functions of your massage chair right from the start, please read this manual carefully, in particular the safety instructions.

© 2023 **brainLight** – All rights reserved.

No part of this work may be reproduced in any form (print, scan, photocopy, microfilm or any other method) without written permission by **brainLight** GmbH and no part of this work may be processed or copied using electronic devices.

Contents

Safety Instructions	4	Customization and Additional Functions	18
Contraindications	4	Reclining Position	18
Installation and Operation	4	Automatic Recline Positions	19
During Use	5	Air Pressure Massage	19
Emergency Stop	5	Foot Sole Massage	20
The Chair Components	6	Seat Swing	20
Setup Instructions	8	Infrared Heating	20
General Instructions for Use	11	Manual Adjustments	21
The Remote Control	12	Troubleshooting, Maintenance & Care	22
Symbols on the LCD Screen of the Remote Control ..	13	Troubleshooting: No Power	22
The Massage Functions	14	Replacing the Main Fuse	22
Automatic Programs	14	Cleaning and Care	23
Semi-Automatic Programs	15	Technical Specifications & Customer Service	25
Manual Massage Settings	16		

Safety Instructions

NOTE: Please read the safety instructions carefully before using your chair. **In order to avoid damage, accidents and injuries, the following advice should be adhered to:**

Contraindications:

- People with any of the following conditions are advised to consult their physician or therapist before using the Shiatsu massage chair:
 - People with heart diseases
 - People with severe tumors
 - Women during pregnancy or menstruation
 - People with abnormalities or curvature of the spine
 - People undergoing medical treatment
 - People with osteoporosis.
- People suffering from thrombosis or similar vein conditions are advised not to use the foot and calf massage functions.
- Children, those who are ill and people with relevant disabilities should only use the chair under the supervision of an adult or carer.
- People weighing more than 120kg / 19 stone / 265 lbs are not permitted to use the chair.

Installation and Operation:

- Position the chair only on a flat, level surface.
- Do not place or use the chair in a dirty, oily, foggy or damp environment.
- Do not expose the chair to direct sunlight and do not place it too close to other electrical appliances.

CAUTION:

- In order to avoid injuries and damage to the chair, please do not sit or stand on the footrest and please do not lean or sit on the armrests.
- Do not take the chair apart! Do not attempt to dismantle, repair or modify the chair without the technical guidance of **brainLight**. If repairs are carried out without the appropriate expertise and skill, you might lose the eligibility for claims based on statutory warranty.
- Please regularly check the foam insert (attached with velcro) and the zipped fabric cover beneath the backrest of your massage chair. In order to ensure optimum performance and to avoid damage, the foam insert and the zipped fabric cover must be replaced after 1000 uses, or earlier if they rupture or show signs of severe deterioration. If you have any questions concerning the upkeep of your chair

Safety Instructions

please contact **brainLight**.

- Put a towel underneath your head when using hair gel or oil- or wax-based hair products to protect the cover material of the chair.
- Please handle the remote control with care and press the buttons only with dry hands. A light touch with your fingertips is enough to operate the chair. Please do not use any sharp objects to operate the remote control (pens, fingernails, etc.).
- Please unplug the power cord from the wall socket when the chair is not in use.

During Use:

- Do not allow children to play on the chair.
- Keep hands and feet away from the mechanics of the chair.
- Do not use the chair in a wet condition and do not operate the chair with damp hands.
- Sit in the chair in an upright position.
- Do not insert any objects into the mechanics, seat cushion, or footrest of the chair.
- The massage chair should not be used by more than one person at a time.
- Do not eat or drink while using the massage chair.

CAUTION: If you feel unwell or ill when using the chair, please pause your session **immediately** by pushing the **emergency stop button**. **Alternatively, you can press buttons 34 or 35 on the remote control:**

1. Emergency Stop Button: On the inside of the right side panel of your massage chair (see picture on p. 7), there is an emergency stop button that is easy to reach from any chair position. Push it for about **1.5 seconds** to stop the massage immediately; the chair keeps its position. Hold the button down for about **3 seconds** in order to not only stop the massage but also have the chair and massage rolls return to their resting position.

2. Stop Button (34) on the remote control (see p. 12): When you press this button, the massage stops and the massage rolls return to their resting position. The massage chair keeps its current position.

3. Power Button (35) on the remote control (see p. 12): When you press this button, the massage stops; both the massage rolls and the chair return to their resting position.

Chair Components

Headrest with two easily exchangeable pillows

Adjustable air bags for upper arm / shoulder air pressure massage

Remote control

Backrest with integrated massage rolls and 4D sensor

Air bags for hand & arm air pressure massage

Air bags for thigh air pressure massage

Left side panel & armrest

Seat area with seat swing massage

Accessory bag *

Air bags for calf air pressure massage

Chair base with casters

Air bags for foot air pressure massage

Massage rolls for foot sole massage

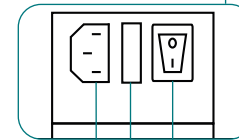

Main switch box on the back of the chair

Main switch
Cartridge with main fuse
Power cable connection

* The accessory bags for storing the remote control, your tablet, mobile phone, book, magazines, etc. can be attached to both armrests with velcro.

Chair Components

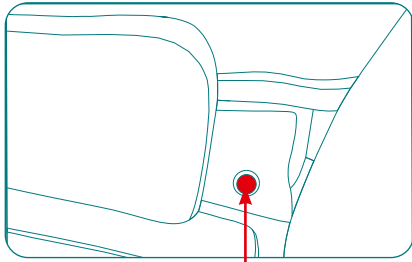

Right side panel with emergency stop button on the inside

Remote control holder (can be optionally installed)

Remote control connection

USB connection

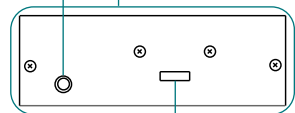
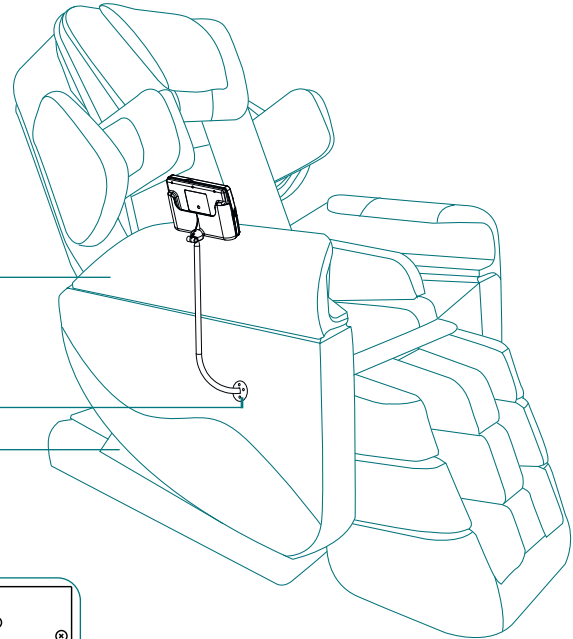

Setup Instructions

If your massage chair was delivered by **brainLight**, it is already assembled and ready for your first session. If you would like to set your **brainLight** chair up yourself, please proceed as follows:

Preparation:

The 4D-Shiatsu-Massage-Chair Zenesse is packaged and delivered in two boxes. In box no. 1 you will find:

- the backrest,
- the backrest cover,
- both side panels,
- the small and the big pillow,
- the remote control with an attached cable,
- the remote control holder,
- 2 accessory bags, and
- a spare foam insert for the back area.

In box no. 2 you will find the chair base.

Unpack the boxes, remove all packaging material, and make sure that none of the parts listed above are missing. Take care not to damage the chair and accessories with sharp or pointed tools.

CAUTION: Keep packaging material, especially plastic bags, out of the reach of children!

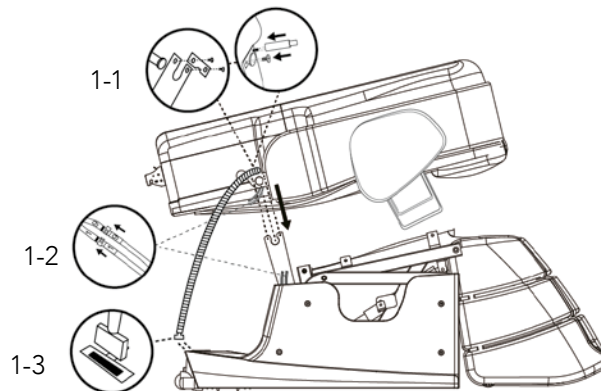

Step 1: Connecting the backrest to the chair base

Step 1:

1-1 Lay the backrest on top of the chair base, let the metal pins on both sides of the backrest click into the gaps of the metal housing of the chair base, and fasten the mountings in place.

1-2 According to their marking, connect the two air pipes on the left side of the chair base with the compatible two air pipes on the lower left of the backrest.

1-3 Afterwards, plug the 24-pole connector into the socket on the back of the chair base. Now, carefully pull the backrest up and backwards until it clicks into place.

Setup Instructions

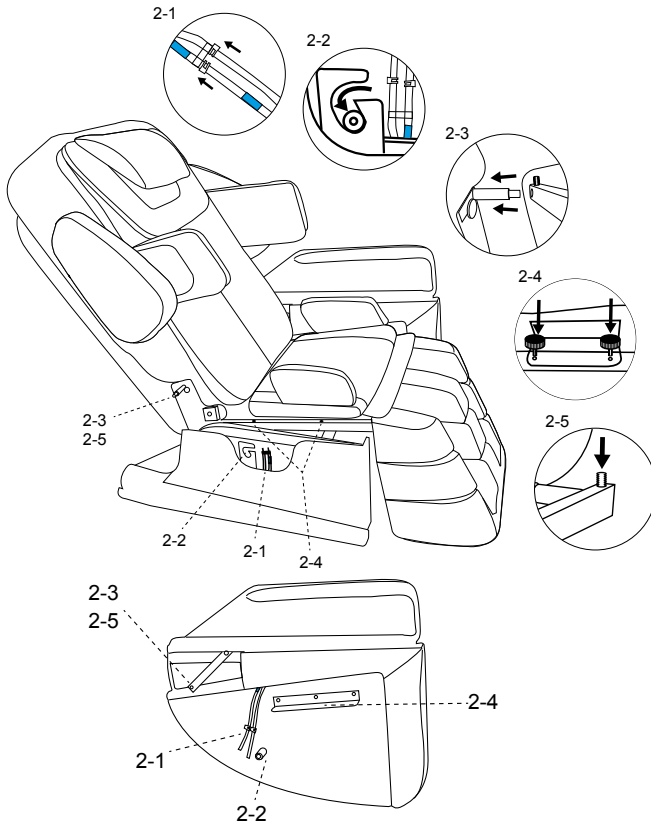

Step 2: Connecting the side panels to the chair

Step 2: Position the side panels to the left and right of the chair. In order to prevent damage, please place some padding (thick fabric, rugs, etc.) underneath the side panels.

2-1 On both sides of the chair base as well as on the inside of each side panel you will find two color-coded air pipes. Connect air pipes of the same color and secure the connections with the metal clips.

2-2 Guide the white connecting bars of the side panels into the black metal mounts on the chair base. Make sure that the air pipes are positioned **in front of** the connecting bars and don't get trapped.

2-3 Connect the black metal mount with the black connecting rod, but **do not** fasten the black locking screw yet.

2-4 Lift up the seat cushion, position the black metal bracket of the side panel in line with the metal casing of the chair base and firmly screw the side panel to the chair base with the two knurled-head screws.

2-5 Firmly push the black metal mount onto the black connecting rod and now fasten the black locking screw.

Setup Instructions

Step 3:

3-1 Attach the backrest cover to the backrest with velcro. Pull the big pillow and then the small one through the loop on top of the backrest cover.

3-2 Find the cable for the heater on top of the backrest cover and connect it to the corresponding cable on the top of the backrest.

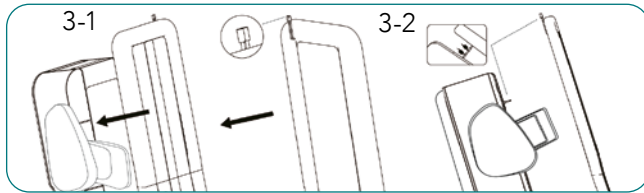

Step 3: Attaching the backrest cover and connecting the heater cable

Step 4:

4-1 Attach one or both accessory bags to the velcro strips on the inside of the side panels. The remote control can be kept in the accessory bag on the right side panel or, optionally, in the remote control holder that is included in delivery.

4-2 If you would like to attach the remote control holder, proceed as follows: Underneath the fabric cover of the right side panel you can feel three preinstalled holes in the position as marked in the picture. Attach the remote

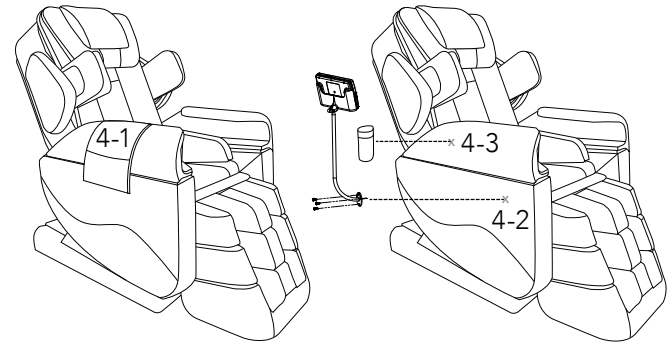

Step 4: Attaching the accessory bags, remote control holder, and fabric case for the glasses

control holder here with the three screws included in delivery. Now, you can slide the remote control into the holder.

4-3 The included fabric case for the glasses can be attached to the armrest of the right side panel in the position as marked in the picture. It stays in place magnetically. You can use the case to store your own glasses, or – if you have purchased a **brainLight-Complete-System** – the **brainLight-Visualization-Glasses**.

Step 5:

Connect the power cord with the main switch box on the chair and plug it into a power outlet. Check again to ensure all steps are complete – your **brainLight** massage chair is now ready for use.

General Instructions for Use

First Steps:

Connect the massage chair to a power outlet and afterwards turn the main switch on, which you will find on the lower left of the back of the chair (see picture on p. 6). When you turn on the chair, you will hear a beeping sound and the display of the remote control will light up.



Choose one of the automatic programs on the remote control. Alternatively, create your own program by manually combining massage components of your choice.

On the following pages, you will find detailed descriptions of the operating elements as well as the massage and additional functions of your massage chair.

Stopping the massage:

You can stop a massage program easily at any time and from any chair position by pressing the **emergency stop button** that you will find on the inside of the right side panel of your massage chair (see p. 7).

In addition, in order to stop a massage program, you can use **buttons 34 and 35** on the remote control:

34



STOP: Press this button in order to stop a massage program. The massage rolls return to their resting position, while the chair keeps its current position.

35



POWER: Press this button in order to turn the chair on or off. When turning the chair off, both the massage rolls and the chair return to their resting position.

After the massage is finished:

At the end of the chosen massage program, the massage stops and the chair automatically returns to its resting position.

CAUTION: When you are finished using the chair, please turn it off on the main switch and disconnect it from the power outlet.

The Remote Control

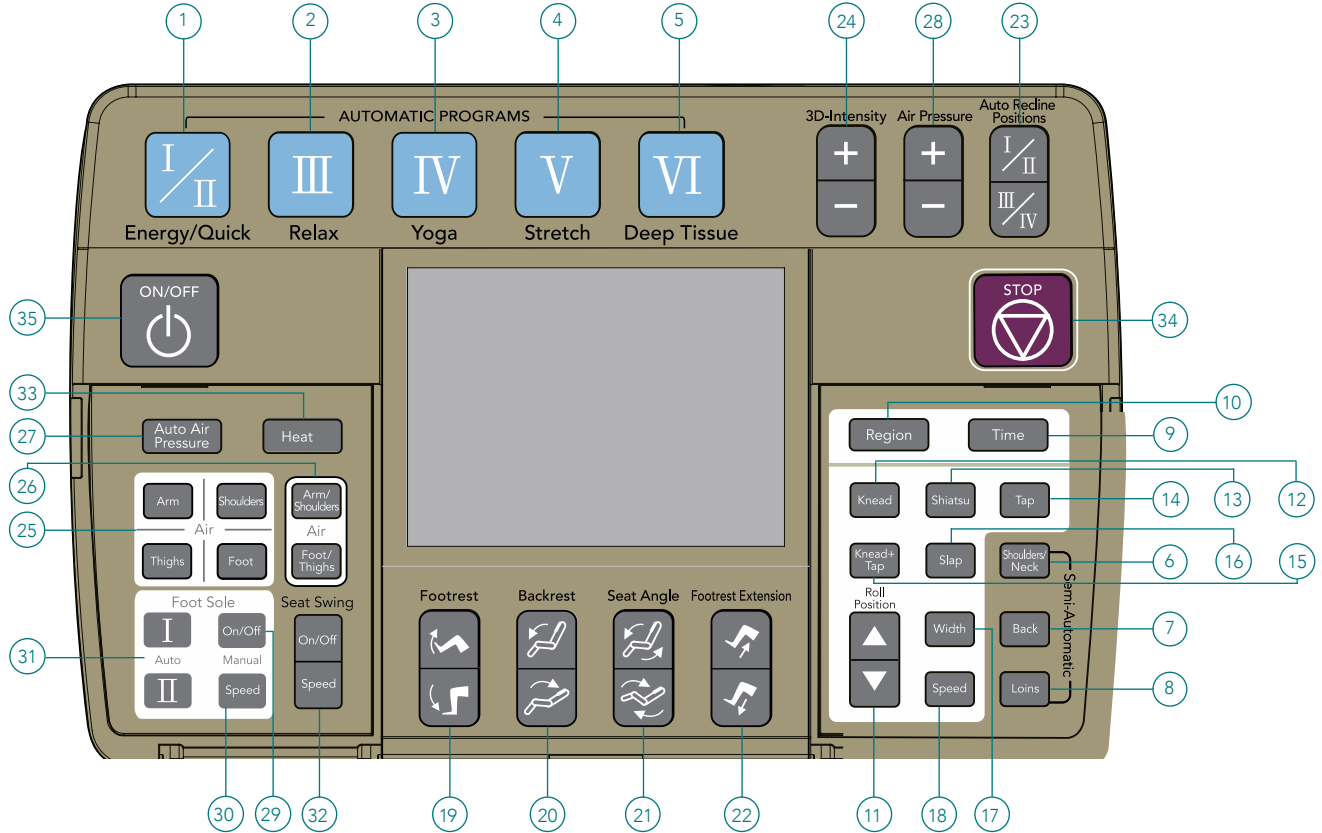

Symbols on the LCD Screen of the Remote Control

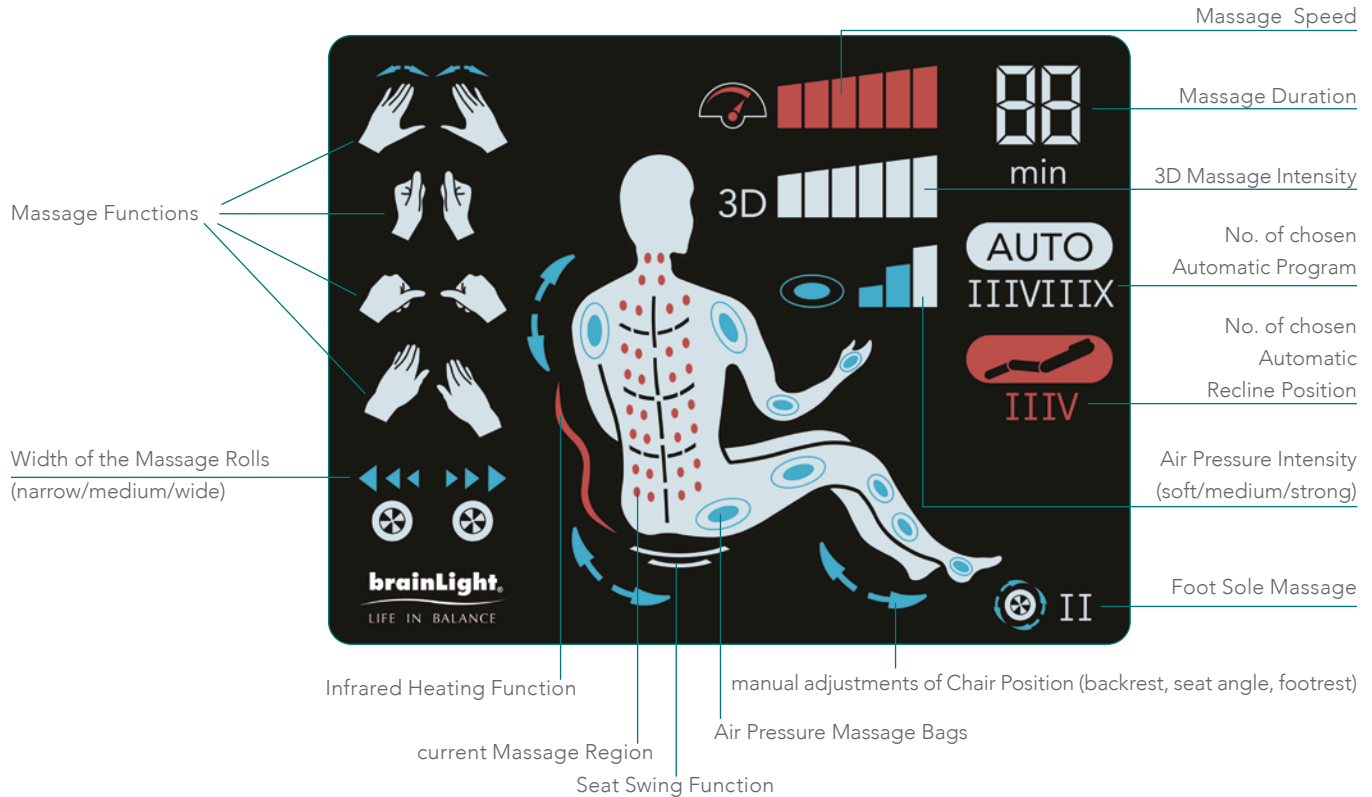

The Massage Functions





Automatic Programs (buttons 1 – 5)



You can choose from six automatic programs with a preset duration, which contain a combination of various back massage functions, air pressure massage functions, the foot sole massage, and the seat swing function. The chair automatically moves into a recline position.

At the beginning of the program, the massage chair detects your back and neck length as well as your back contours with the help of a sensor, which is attached to the massage rolls. This locates your acupressure points and the massage program is specifically tailored to your upper body. In addition, when the footrest moves towards you, stop it at a comfortable length by pushing against it with your feet.

The automatic programs are constructed around themes, which are specified in the titles:

- 1  **I ENERGY 16 min** (push button once): A program aimed at energizing your mind and body.
II QUICK 8 min (push button twice): A program designed for giving you a quick energy boost; short version of I.
- 2  **III RELAX 16 min**: A program designed for relaxing and releasing tension.
- 3  **IV YOGA 16 min**: A program that stretches as well as strengthens your muscles and activates energy points.
- 4  **V STRETCH 16 min**: A program focused on stretching all of your muscles and joints.
- 5  **VI DEEP TISSUE 30 min**: An in-depth program focused on loosening and detoxing your deep tissue.

At the end of the program, the massage stops and the chair automatically returns to its resting position.

The Massage Functions

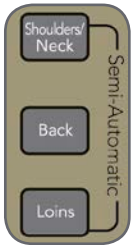

Semi-Automatic Programs (buttons 6 - 8)



You can choose from three semi-automatic programs with a preset duration, which — according to their title — focus on the “Shoulders/Neck”, “Back”, or “Loins” area, using only the back massage functions as default.

At the beginning of the program, the massage chair detects your back and neck length as well as your back contours with the help of a sensor, which is attached to the massage rolls. This locates your acupressure points and the massage program is specifically tailored to your upper body.

Please use buttons 19 - 23 to set your recline position. When the footrest moves towards you, stop it at a comfortable length by pushing against it with your feet. Furthermore, you can add air pressure massage (buttons 25 - 28), foot sole massage (buttons 29 - 31), seat swing (button 32), and heating in the back area (button 33).

- 6  **Shoulders and Neck Massage** 12 min
Massage program focusing on shoulders and neck.
- 7  **Middle Back Massage** 12 min
Massage program focusing on the middle back.
- 8  **Loins Massage** 12 min
Massage program focusing on the loins.

At the end of the program, the massage stops and the chair automatically returns to its resting position.

The Massage Functions

Manual Massage Settings

9  Use this button to set or change the **massage duration**. You can choose 5, 10, 15, 20, 25, or 30 minutes. Once the set length of time is finished, the massage stops and the chair automatically returns to its resting position.

10  With the help of this button, you can set the **massage region** for the back massage functions. Choose between the **whole back**, the **shoulders and neck area**, the **middle back**, the **loins**, or a **specific point**.

11  If you choose to be massaged at a specific point along your back, you can adjust the **position of the massage rolls** with the help of the arrow buttons.

NOTE: In order to be able to adjust the position of the massage rolls, press the Region button (10) until no region is selected on the display of your remote control.

Select the desired **back massage function** with buttons 12 - 16 and adjust the "Width" of the massage rolls (button 17), the massage "Speed" (button 18), and the "3D-Intensity" (button 24) according to your wishes. Furthermore, you can add air pressure massage (buttons 25 – 28), foot sole massage (buttons 29 – 31), seat swing (button 32), and heating in the back area (button 33).

12  Press this button for the **kneading massage** to

- rotate inside out (push once),
- rotate outside in (push twice), or
- turn off (push three times).

With button 18, you can adjust the speed of the kneading massage to your needs (6 levels, preset to level 3).



13  Press this button to turn the **Shiatsu massage**

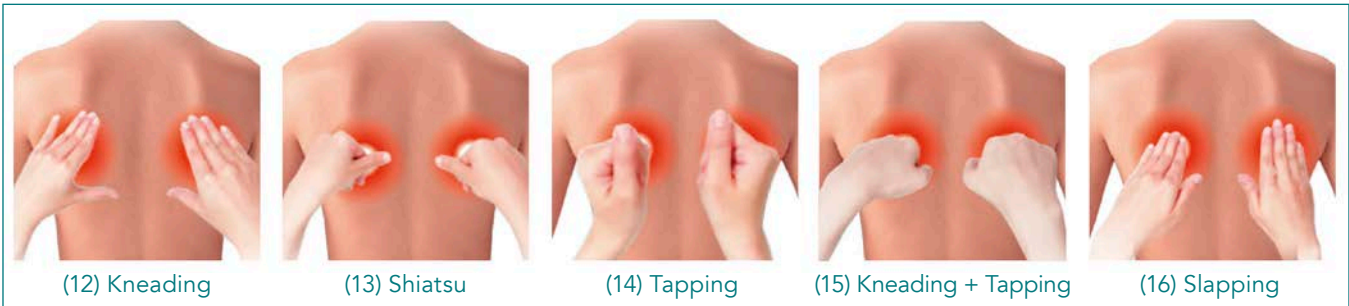

- on (push once), or
- turn off (push twice).

With button 17, you can adjust the width of the massage rolls to your needs.

The Massage Functions



- 14  Press this button to turn the **tapping massage**
- on (push once), or
 - off (push twice).
- With button 17, you can adjust the width of the massage rolls to your needs and with button 18, you can adjust the massage speed (6 levels, preset to level 3).
- 15  Press this button to turn the **combined kneading + tapping massage**
- on (push once), or
 - off (push twice).
- With button 18, you can adjust the massage speed to your needs (6 levels, preset to level 3).

- 16  Press this button to turn the **slapping massage**
- on (push once), or
 - off (push twice).
- With button 17, you can adjust the width of the massage rolls to your needs and with button 18, you can adjust the massage speed (6 levels, preset to level 3).
- 17  Press this button to adjust the **width of the massage rolls** in three steps (wide, medium, or narrow).
- NOTE:** The width of the massage rolls **cannot** be adjusted for the kneading and combined kneading + tapping massage functions.

The Massage Functions

18  Use this button to adjust the **speed for the manual massage functions** in up to 6 levels (preset is level 3).

24  Use these buttons to adjust the **3D intensity of the back massage functions** in up to 12 levels.

Additional and Adjustment Functions

Recline Position: You can adjust the backrest, seat angle, and footrest independently with the buttons 19 - 22 in order to create your ideal recline position. Alternatively, choose one of the four automatic recline positions with the help of buttons 23.

19  FOOTREST: Use these buttons to adjust the angle of the footrest.

20  BACKREST: Use these buttons to adjust the recline angle of the chair until you have found a comfortable position.

21  SEAT ANGLE: Use these buttons to adjust the angle of the seat. Your body weight is shifted so that you can experience a feeling of weightlessness and floating.

22  FOOTREST EXTENSION: Use these buttons to set the footrest to a comfortable length. The three part footrest (with floor-protecting castors at the bottom) can be extended by 22 cm and adjusts to your leg length automatically at the beginning of the automatic programs and the automatic recline positions.



The Massage Functions

Automatic Recline Positions

23 You can choose between



I Floating 1: a lightly reclined chair position that conveys a sensation of floating,

II Floating 2: a further reclined chair position that conveys a sensation of floating,

III Heart Balance Position: a chair position that relieves the spine and supports circulation, and

IV Inversion: a chair position that stimulates the activity and oxygen supply of the brain.

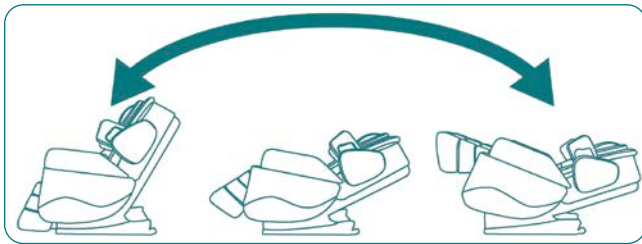

Air Pressure Massage

Air pressure massage can be selected for various areas individually or in combination.





The Massage Functions

Use the following buttons to turn the **air pressure massage** on or off for

25  – individual areas (arm&hand, upper arms&shoulders, thighs, foot&calf)

26  – combined areas (arm&hand/upper arms&shoulders or foot&calf/thighs)

27  – all areas simultaneously.

28  With these buttons, you can adjust the air pressure intensity in 3 levels for the selected area(s).

Foot Sole Massage

29  Turn the **foot sole massage** on or off (button 29). You can choose between automatic sequences I and II (button 31) as well as the manual setting (button 30) that lets you choose between 3 levels of speed.

30  On/Off

31  Auto Manual

 Speed

Seat Swing

32  Turn the **seat swing function** on or off and choose between 2 levels of speed. The seat of your chair starts swinging, which aims at releasing tension in the hip and pelvis area.

Infrared Heating

33  Turn the **infrared heating function** of your massage chair on or off with this button. It revitalises your cells and improves the blood flow in your back. After approx. 10 minutes, this function turns itself off automatically.

Manual Adjustments

Shoulder Massage Unit



The air cushions for the upper arm and shoulder massage (see picture on p. 6) are manually adjustable in five steps.



Depending on their position, the shoulders or the upper arms are massaged, attuned to your height.



Back Massage Intensity



If you would like a stronger back massage, you can fold back the pillows and also take the foam insert out of the back area. It is attached by velcro on the backrest, underneath the backrest cover.

Foot Sole Massage Intensity



If you would like a stronger foot sole massage, you can easily remove the foam insert pads located in the foot area.

Troubleshooting, Maintenance & Care

Troubleshooting: No Power

Step 1:

Make sure the chair is switched on. The power switch is located on the bottom left side of the backrest (see p. 6). The icon "-" is pushed inwards when switching on the chair. If you still have no power, continue with step 2.

Step 2:

Check both ends of the power cord and make sure it is firmly plugged into the chair as well as into the socket. If you still have no power, continue with step 3.

Step 3:

Test the socket with another electrical appliance. If the socket works but the chair does not, continue with step 4.

Step 4:

Replace the main fuse (7 amps) of the chair.

Replacing the Main Fuse

CAUTION: Always switch off the chair and unplug the power cord from the socket before undertaking any kind of maintenance work.

Step 1:



Unplug the power cable from the chair itself. You will find the cartridge containing the main fuse between the power cable and the main switch.

Step 2:



Use a small flathead screwdriver to carefully unhinge the fuse cartridge and pull it out.

Troubleshooting, Maintenance & Care

Step 3:

Replace the fuse in the clamp (fuse currently in use) with the fuse in the square enclosure (spare fuse). Additional fuses (7 amps) can be purchased at any electronics store.

CAUTION: Only use fuses with the correct amount of amps in order to avoid damage to the massage chair.

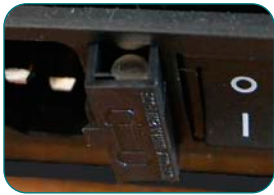

Push the cartridge with the exchanged fuse back into place.

Step 4:

Plug the power cable back into the chair and connect the chair to a socket. Test whether the chair works. When you switch on the chair, you should hear a "beep" sound and the remote control display lights up.

Cleaning and Care of Chair and Remote Control

CAUTION: Switch off the chair and unplug the power cord from the socket before cleaning the chair and remote control. Only clean the outside of the chair! Use a soft cloth to brush dust off the chair parts that are not covered in (artificial) leather. The remote control can be gently wiped with a slightly moist cloth and dried with a dry soft cloth. By default, the massage chair is upholstered with artificial leather. Therefore, it can be easily cleaned and, if necessary, also disinfected.

Cleaning the Leatherette Cover of the Chair

Basics

Artificial leather (or leatherette) is a comparatively hard-wearing material. The following cleaning and care advice is aimed at preserving the appearance and quality of your massage chair:

- As is true for all upholstered furniture, the cover material of your massage chair can fade or wear out more quickly by being exposed to direct sunlight or heat (for example by being placed next to a radiator). Choosing the right place and using curtains and blinds can counteract this effect.

Troubleshooting, Maintenance & Care

- Over time, artificial leather loses its plasticizers and can become dry and brittle. This process cannot be prevented but can be delayed by treating your massage chair with care and cleaning it regularly. It is also possible to have the cover of your chair replaced in part or fully through us (prices on request).

Cleaning and Care

Step 1: Moisten a soft cloth with lukewarm water, which contains a mild cleaning detergent (do not use solvents or abrasive products - please note the cleaning product recommendations on our website). The cloth should only be slightly moist. Wipe the chair down by moving from one area (enclosed by seams) to the next; move from the edges towards the center with circular motions.

Step 2: Afterwards, repeat the process with a soft cloth that is moistened with lukewarm water without any cleaning detergent.

Step 3: Dry the cover with another dry, soft cloth.

Removing Stains and Dirt:

- The quicker you remove dirt or stains, the better the result.
- Absorb spilled liquids with a soft cloth and subsequently clean the affected area in three steps as described.
- Do not scrape off dried-up dirt, but carefully push it off with a blunt object (such as the blunt back of a knife) and subsequently clean the affected area in three steps as described.
- You can use a soft brush to treat tougher stains. Wet the brush with lukewarm water, which contains a mild cleaning detergent (do not use solvents or abrasive products - please note the cleaning product recommendations on our website). Then, clean the affected area in three steps as described.

NOTE: The advice given does not constitute a guarantee and does not exempt you from your duty to exercise diligence with your massage chair and the cleaning products you use. We assume no liability for any damage occurring during and/or from the cleaning and care of the chair.

Technical Specifications & Customer Service

Technical Specifications

Product Name:

brainLight-4D-Shiatsu-Massage-Chair *Zenese*

Vertical range of the massage rolls: **77 cm (approx. 2.5 ft)**

Position angles of the chair: **110° – 216°**

Operating voltage: **AC 220 – 240 V; 50 Hz – 60 Hz**

Wattage: **150 W**

Motor voltage: **24 V**

Weight: **120 kg +/- 3 kg**



Dimensions: **approx. L 148 (200) cm x W 78 cm x H 120 (98) cm / approx. L 4.9 (6.6) ft x W 2.6 ft x H 3.9 (3.2) ft**

The numbers in brackets relate to the dimensions of the chair reclined fully with the footrest in an horizontal position.

When combined with the **brainLight** relaxTower or the **brainLight**-Synchro PRO, the **brainLight**-4D-Shiatsu-Massage-Chair *Zenese* can be upgraded to a **brainLight**-Complete-System for a holistic relaxation of mind and body (<https://www.brainlight.com/products/brainlight-complete-systems-e/>). Please visit **www.brainlight.com/bl-support/faq-e.html** for answers to frequently asked questions (FAQs) and for documentations as well technical and product information available for download.

Warranty and Customer Service

The warranty and guarantee periods adhered to by **brainLight** are as follows:

Private customers:

- 24 months warranty for new goods.
- 12 months warranty for used goods.
- 24 months guarantee for new goods.
- 6 months guarantee for used goods.

Commercial customers:

- 12 months warranty for new goods.
- 6 months warranty for used goods.
- 6 months guarantee for new and used goods.

If you have any questions regarding your **brainLight**-System or if a repair is necessary, please contact the **brainLight** customer service:

via phone: service hotline +49 (0)6021 5907-10
(Monday to Friday, 9 am to 5 pm)

via e-Mail: kundenservice@brainlight.de
We will get back to you promptly.

Relaxation technology Made in Germany!



brainLight GmbH • Hauptstraße 52 • 63773 Goldbach • Germany
Phone: +49 (0) 6021 59070 • Telefax: +49 (0) 6021 540997 • E-Mail: info@brainlight.de
www.brainlight.de + www.brainlight.com

brainLight®

LIFE IN BALANCE

◆◆◆ Est. 1988 ◆◆◆